

Foton FW2000-WF-H Руководство по эксплуатации



2000 watts fiber handheld laser welding machine manual user

- How to connect 3 phase power supply
- How to fill up water to water chiller
- How to start the laser welder
- How to connect the wire feeder

How to connect 3 phase 380 Volt power supply

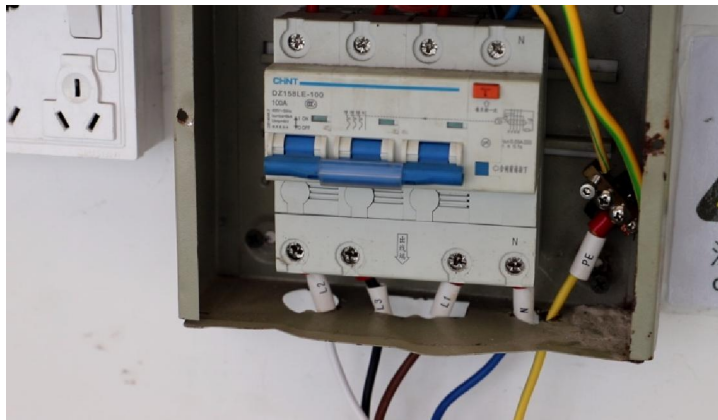
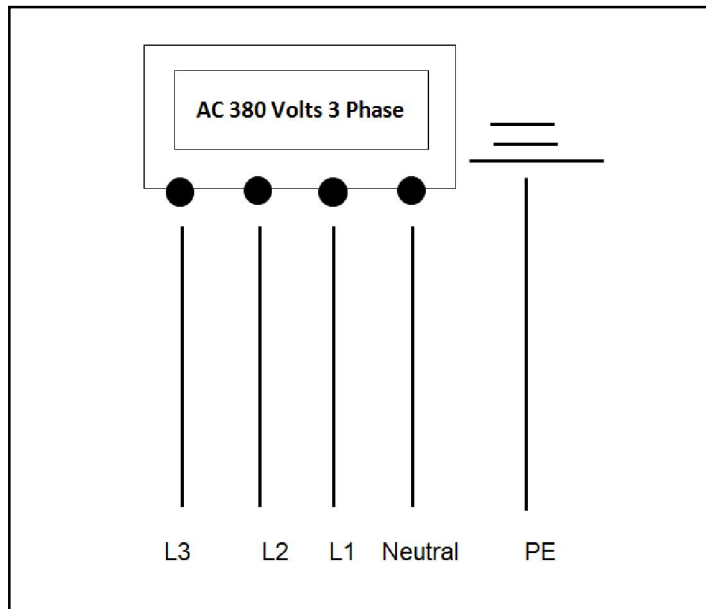

N= Neutral wire (Blue color wire)

PE=Protective earthing conductor (Yellow color wire)

L1, L2,L3 = Live wire

There is no requirement for Live Wire connection sequence

Live wire =brown ,black, white color wire.

How to fill up water to water chiller

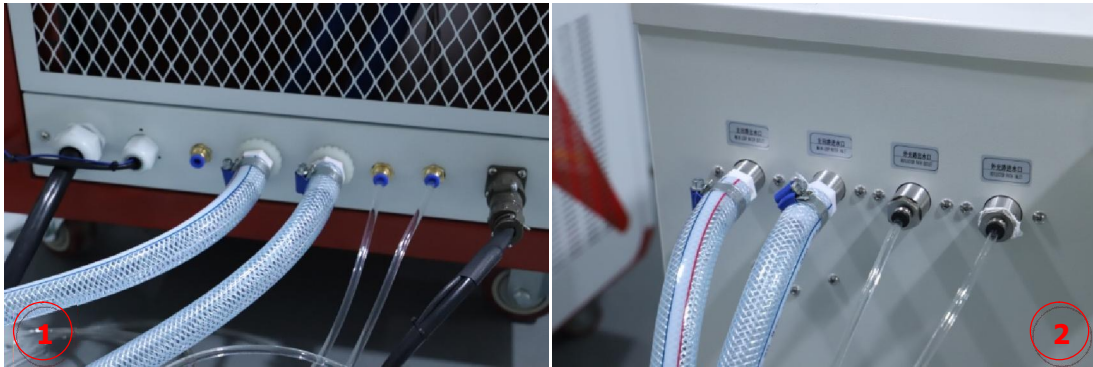

- 1) Picture 1 from left side to right side is Power supply cable , wire feeder power and safety clip wire ,gas hole, A water outlet tube, B water inlet tube, C water outlet tube, D water inlet tube, water chiller power supply. Picture 1 is the laser machine back position.
- 2) Picture 2 from left side to right side is A water outlet tube, B water inlet tube, C water outlet tube, D water inlet tube, Picture is the water chiller back position.



- 3) Open the cover of fill up water hole. Please prepare pure water or distilled water fill up water tank.
- 4) Picture 4 come with water level, when water level over green color position that water chiller water is enough. Once a month replace fresh water.

How to start the machine



- 1) After connected well power supply of the machine. Turn on airswitch button like 2 picture.



- 2) Turn on Emergency, key switch to On position, Laser, Water chiller button.



- 3) Turn on Emergency, key switch to REM position, When green light is On, laser source working. **Don't press start button on the laser source.**

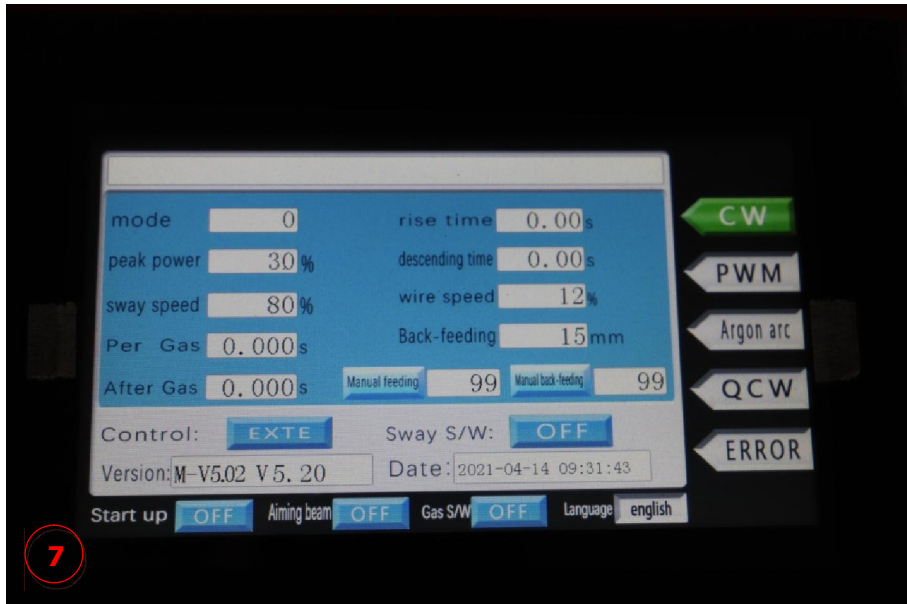

- 4) CW mode: Peak power rate adjust 5 to 100% range, rise time 0.0 s, descending time 0.20s, sway speed 12 to 100% range, Per gas 0.3 to 0.5 s, After gas 0.3 s, Wire speed 1 to 100%, Back-feeding 1 to 99mm range, manual feeding 0 to 99mm, manual back-feeding 0 to 99mm.

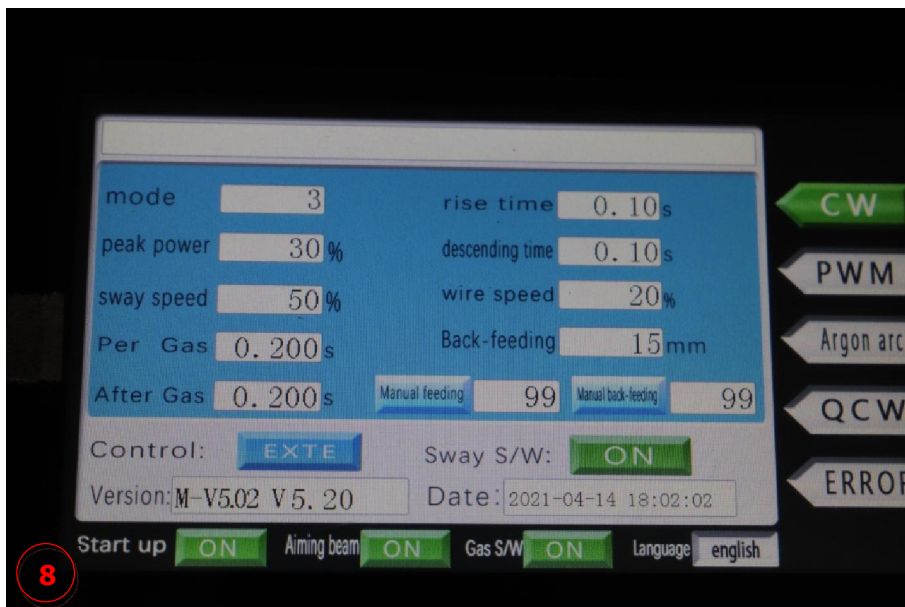

- 5) Once all parameters set up well. Now turn on button of the screen. Sways/w On Start up On, Aiming beam On, Gas s/w On. The machine support argon gas with 3 to 5 bar air pressure. The machine back side come with gas hole that support 6mm diameter with plastic gas tube. Turn on machine before have to make sure Connect argon gas.

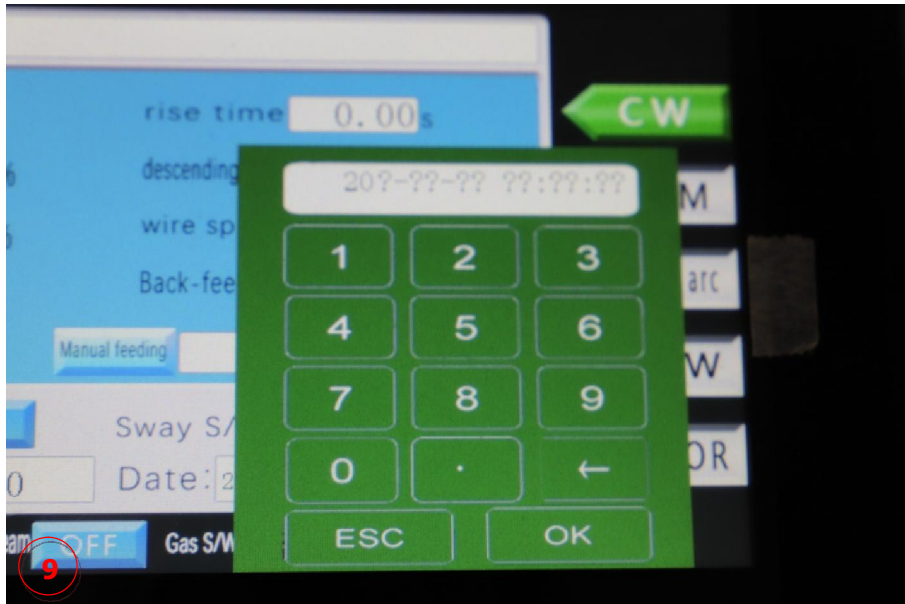

- 6) Date can set up what do you want exactly date and time..Press Date of screen.
Change date of your local time.

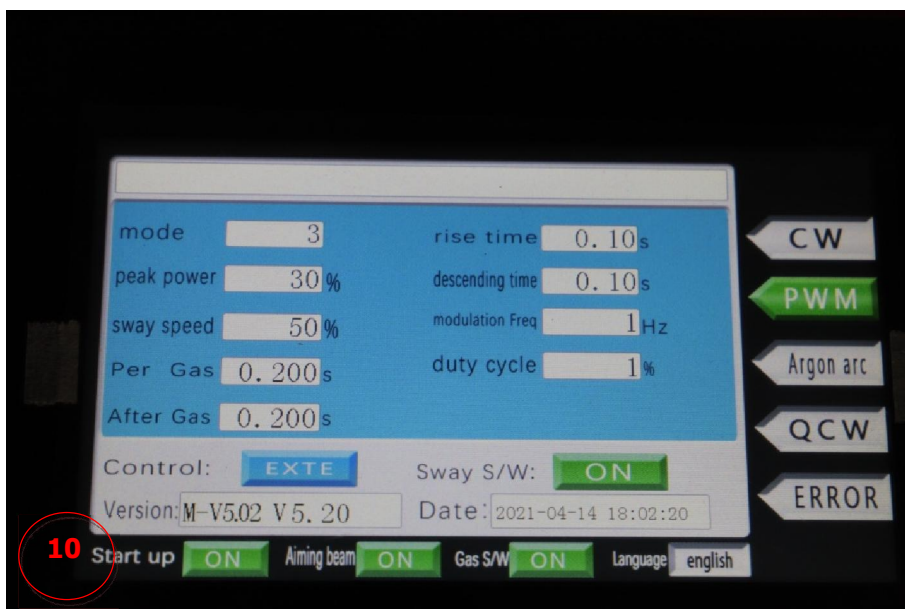

- 7) If you want to weld aluminum material, you have to adjust mode to PWM
After change modulation frequency 1 to 15000Hz, normally use 10000Hz.
Duty cycle adjust 20% to 100%, normally use 85% duty cycle for weld aluminum

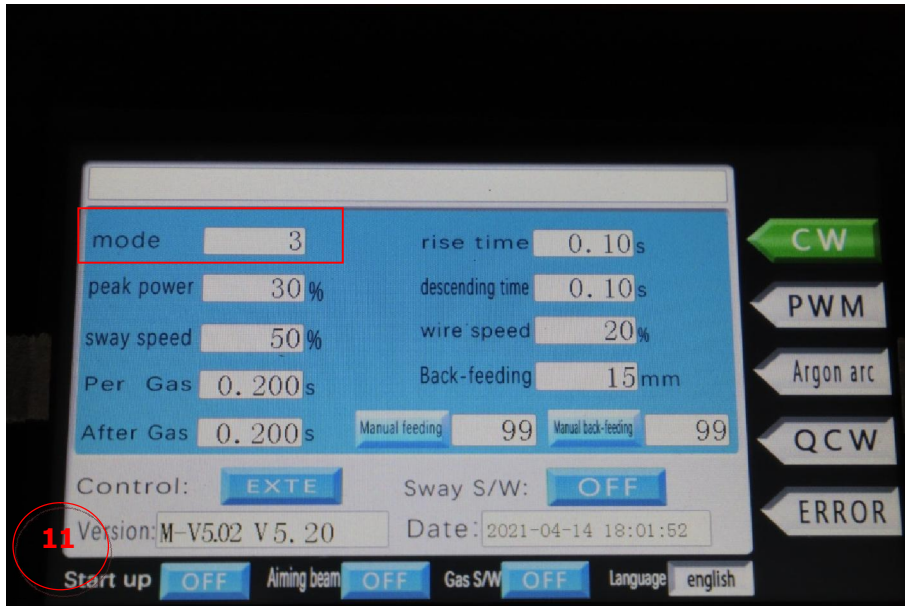

- 8) The machine screen come with 0 to 31 mode parameter. Each mode corresponds to different setting parameters, and the welding parameters of the corresponding material can be saved.

How to connect the wire feeder



- 9) Check wire feeder all accessories are in good condition.
10) Find two connection port of wire feeder like 2 pictures



11) Connect 3 pin port of wire feeder.

12) Connected well like 4 picture, this is wire feeder power supply wire, the other side should connected 220V AC single phase, (Chinese 220V AC single phase)If USA,Canada Mexico should be use a transformer transfer 220V from 110V.



13) Check wire feeder all accessories are in good condition.

14) Find two connection port of wire feeder like 2 pictures

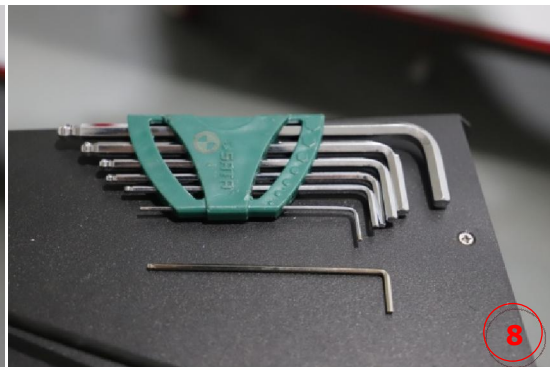
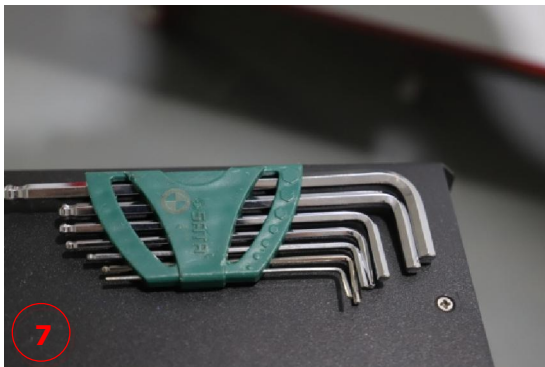

15) Please prepare hex screw tools.

16) Take out of second smallest one, we called it diameter 2mm screw.

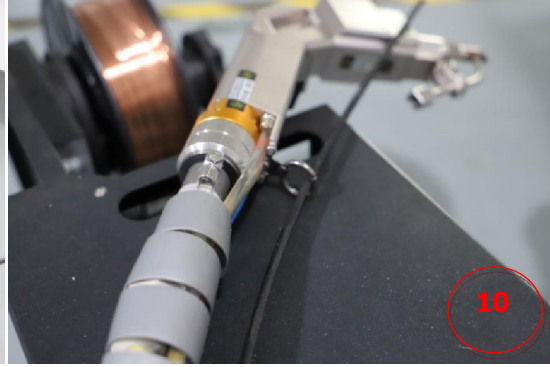
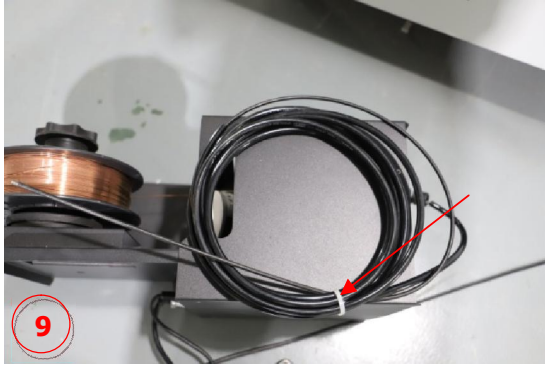

17) Cut off the tie as we fixed wire. Please see marked red color position.

18) Cross wire through circle ring like 10 picture.

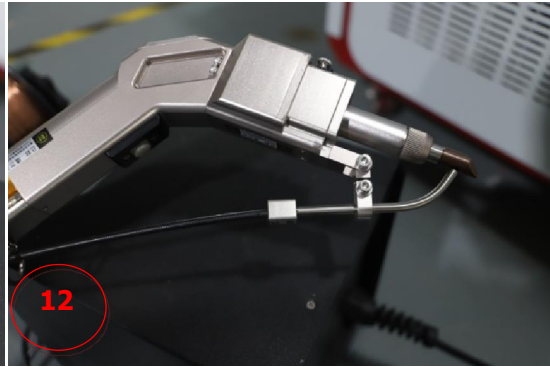
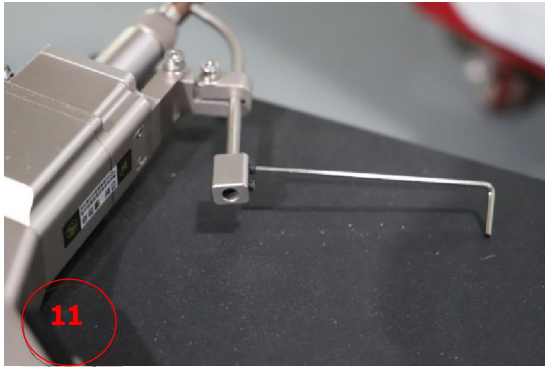

19) Using hex screw to loosen 2 screw of wire feeder fixed device, like 11 picture.

20) Install the wire casing to fixed device after tighten the screws of 2

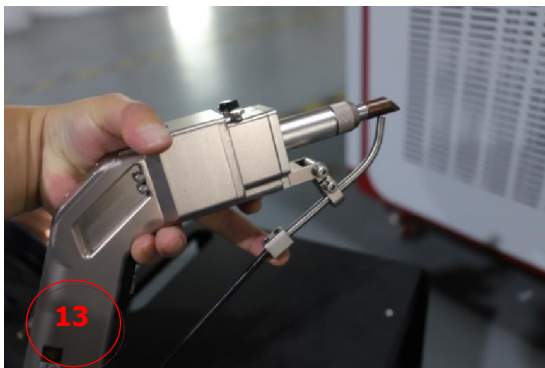

21) Press wire fixed device to other side release

22) Released like 14 picture



23) Wire feeder power supply is single phase with 220 volts 50/60Hz.(Chinese single phase 220 volts

24) Turn on switch of red color of wire feeder.

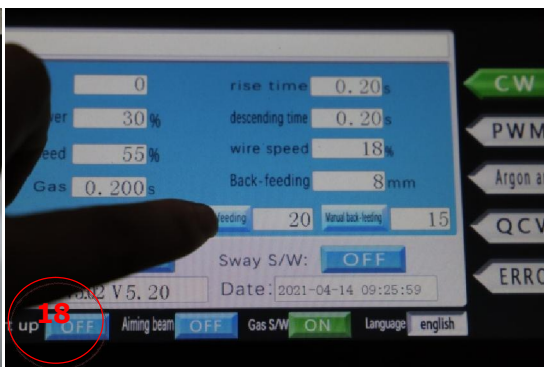

25) Go to back side of the wire feeder to check red light is on. This is normal working situation.

26) Turn on the machine button, emergency button, key switch to On, laser button and Water chiller button ,all of them turn on. Now checking the wire sending on the screen. Continuous press Wire Sending of the screen whiling the wire come through Wire fixed device.

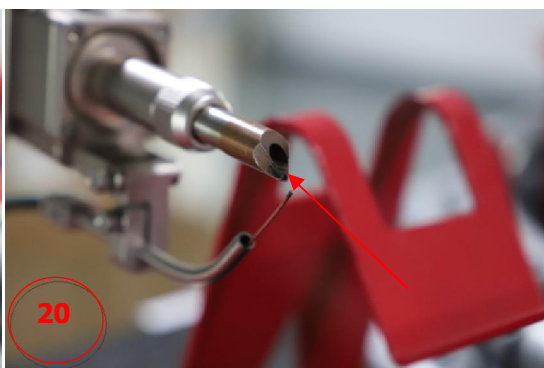

27) Whiling you continuous press Wire sending of screen,then wire coming. 19 picture

28) The weld head nozzle come with very small slot, the main function is to fix the welding wire. See marked position.

